

süd  wind



Decentralised home ventilation
system with integrated heat recovery.

ambientika[®]

Guaranteed quality

The air we breathe indoors is full of pollutants and contaminants that can threaten our health and cause respiratory illness. Chipboard contained in furniture, paints or coatings that can emit toxic substances, as well as smoke particles and carbon dioxide are the main causes. Moisture, mainly caused by the presence of humans, causes mould and damages the fabric of buildings.

To ensure a healthy living environment mechanical ventilation systems are recommended. Advanced systems help achieve savings with a heat exchanger for heat recovery from the exhaust air and through an elaborate system for insulation and sealing the building envelope.

Our Ambientika ventilation system with integrated heat recovery heats the externally supplied fresh air with the waste heat from the used air in the room in the wintertime. In the summertime, when temperatures indoors are lower, the heat exchanger cools the fresh air supplied from the outside. This not only ensures a healthier living environment, but also saves on energy.





Ambientika eco

Ambientika eco

Our decentralised ventilation unit with integrated alternating flow direction and ceramic heat exchanger is supplied with 3 A Ø 160 mm installation pipe and is very low in energy consumption. The unit is ideal for ventilating single rooms such as living rooms or bedrooms. For balanced ventilation, the unit should always be used in pairs with synchronous control. The system represents the perfect solution for maintaining a healthy indoor climate and removing CO₂, impurities and moisture from the air that are capable of adversely affecting the health of the occupants and impairing the building fabric.

 Our Ambientika is an energy-saving, decentralised ventilation unit with integrated heat exchanger that transports stale, contaminated air outside and exchanges it for fresh air. The thermal energy in the exhaust air is used to warm the fresh air from the outside.

 The unit is equipped with a highly efficient, low noise EC motor (brushless) and is based on the concept of reducing energy consumption through „heat recovery“ for heating and air conditioning buildings.

 The ceramic heat exchanger has a thermal efficiency of up to 93% and ensures the best results when it comes to saving energy.

 The unit is equipped with integrated sensors. In AUTO mode, the units regulate themselves, so no further intervention by the user is required.



Products in comparison

Our Ambientika decentralised home ventilation system with integrated heat recovery clearly stands out from comparable products. Why? Simply because it combines innovative technology with exceptionally simple and intuitive operation. Our decentralised home ventilation systems with integrated heat recovery are also very easy to install and are currently among the best and most versatile on the market.

They can also lower the radon levels if properly installed. Ambientika home ventilation systems are also ideal for converted, renovated and refurbished properties, since they are also easy to retrofit without a great deal of effort. The filter can be cleaned in seconds without the need for any tools.



Ambientika advanced B+

It is very popular with energy consultants in particular because they also want to have heat recovery in bathrooms. This fan is therefore 2-in-1: The timer button can be pressed as required, then the fan aspirates at full load for 20 minutes and then switches back to heat recovery mode in order to dry out the moisture which is stored in the walls.

- ✓ Automatic operation
- ✓ Unit supplied with remote control and wall mounting bracket
- ✓ Minimal noise emissions – high-tech fan
- ✓ Optional free cooling
- ✓ Bathroom ventilator



Ambientika solo+

The SOLO model, suitable for single-room solutions, operates autonomously without requiring manual control.

- ✓ Includes a set of G3 filters
- ✓ Compact, versatile, and user-friendly
- ✓ Minimal noise emissions - high-tech fan positioned behind the heat exchanger
- ✓ Remote control for regulating the speed is supplied
- ✓ Automatic operation makes it ideal for rental properties



Ambientika advanced+

With integrated sensor technology

- ✓ Automatic operation
- ✓ Unit supplied with remote control and wall mounting bracket
- ✓ Can be wired to up to 15 other devices
- ✓ Minimal noise emissions – high-tech fan positioned behind the heat exchanger
- ✓ Optional free cooling – direction selectable



Ambientika wireless+

With integrated sensor technology

- ✓ Automatic operation
- ✓ Unit supplied with remote control and wall mounting bracket
- ✓ Can be wirelessly connected to up to 15 other devices
- ✓ Minimal noise emissions – high-tech fan positioned behind the heat exchanger
- ✓ Safe and reliable radio frequency (with built-in transmitter/receiver)
- ✓ Optional free cooling



Ambientika smart

Can be controlled with the Ambientika app or by using a remote control.

- ✓ VOC sensor (air quality)
- ✓ Internal temperature sensor
- ✓ Humidity sensor
- ✓ Light sensor
- ✓ Minimal noise emissions – high-tech fan positioned behind the heat exchanger
- ✓ Compares indoor air data online with the nearest weather station

Optional accessories

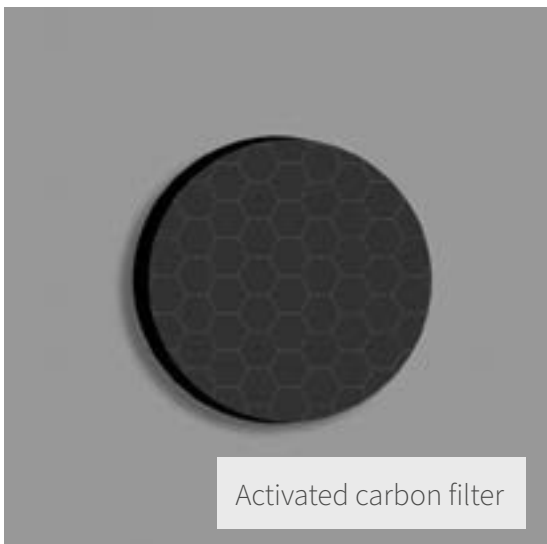
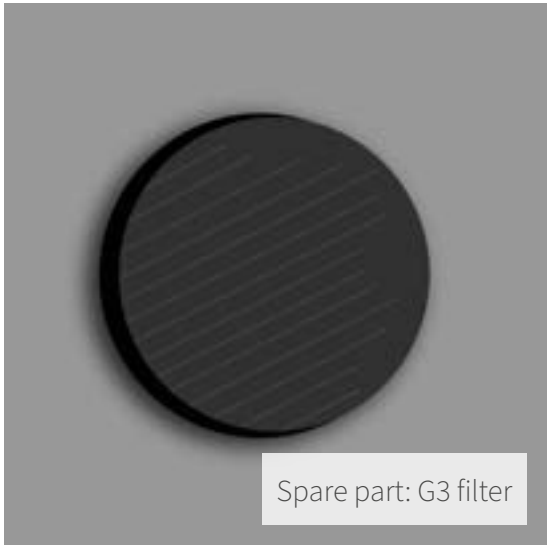

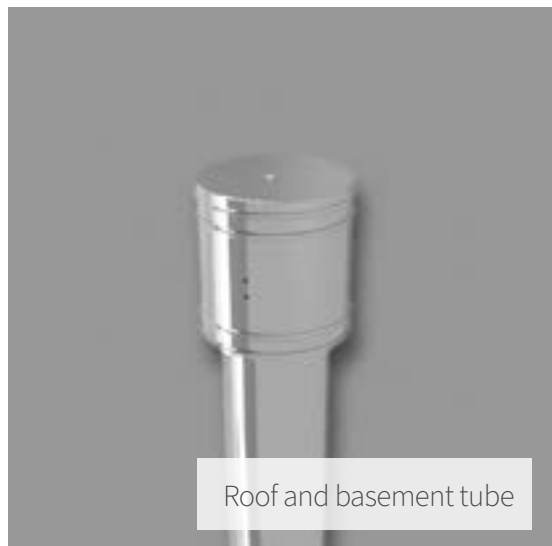
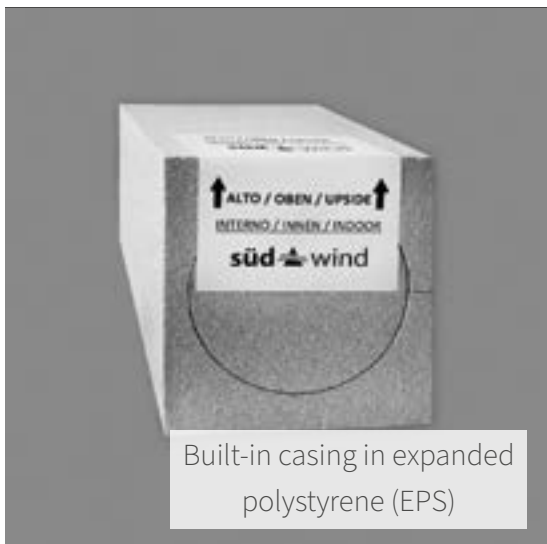
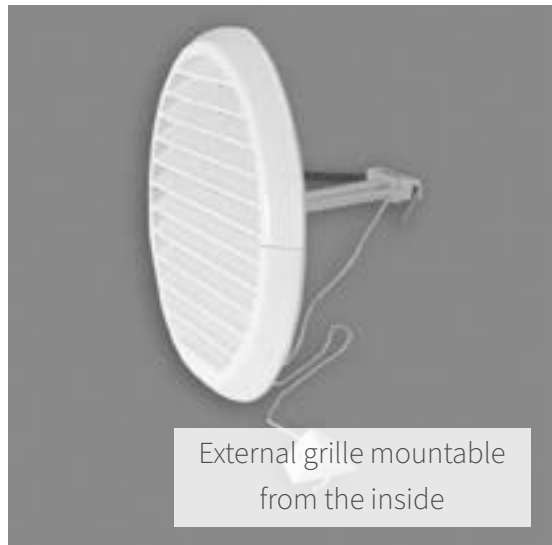
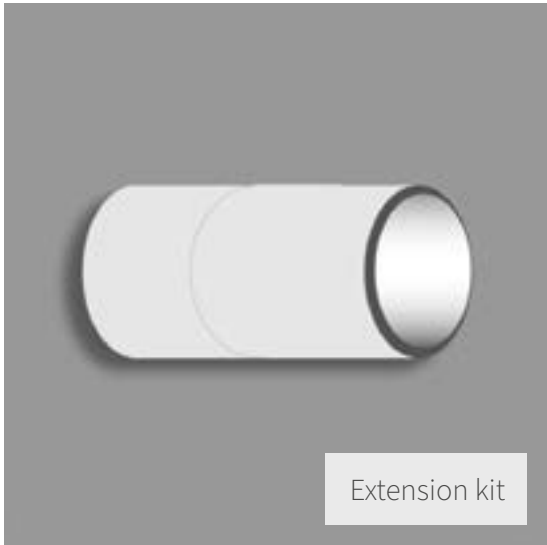



Wall panel

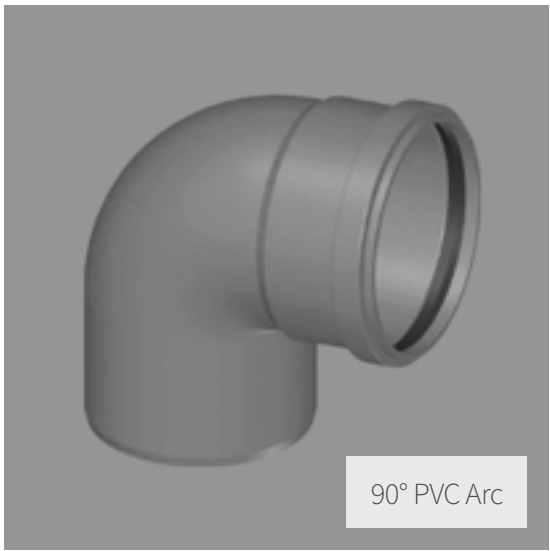

90° PVC Arc

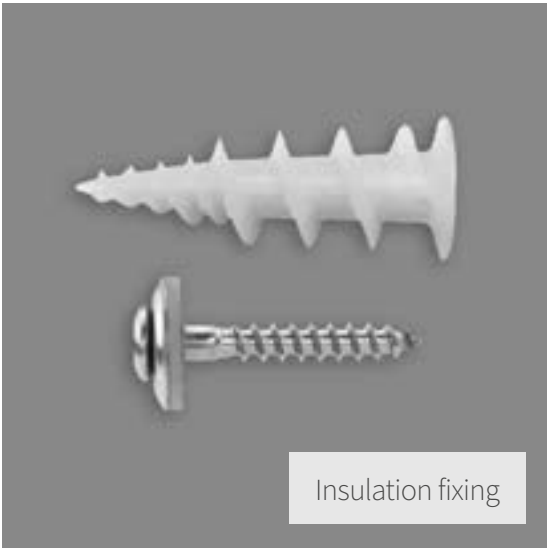

Insulation fixing



Painted outer cover



Remote control



Operating hours counter



Dew point control for dehumidification of cellars



Time delay for SOLO+



Radio receiver for dew point control



Radon meter



Fan control for Radon system



Exhaust fan

Additional Information about accessories can be found on our website at www.ambientika.eu



Remote Control

MODE

AUTOMATIC MODE

The humidity sensor and the twilight sensor are both active. The units therefore run on automatic without having to receive any additional commands.

AUTO

MODE

MONITORING MODE

The units are in idle mode as standard with the shutter closed and the sensors active, and will go into exhaust mode when the humidity exceeds the threshold set.



MODE

MANUAL MODE

The sensors are deactivated and the units are continuously in heat recovery mode. The user can decide at which the speed the units should operate; these settings are kept until changed manually.

MANUAL



NIGHT MODE

In Night Mode, all heat recovery units operate at night speed until a different command is entered.



TIMED EXTRACT MODE

If you press this button in any one of the modes, all units go into extract mode for 20 minutes at maximum speed before they return to the mode previously set at the end of the cycle.



MASTER-SLAVE AIRFLOW MODE

In this mode, the units generate a continuous flow of air that flows from the units set up as MASTER VS SLAVE or MASTER EQUALS SLAVE without heat recovery.



SLAVE MASTER AIRFLOW MODE

In this mode, the units generate a continuous flow of air that flows from the units set up as MASTER VS SLAVE or MASTER EQUALS SLAVE without heat recovery.



EXTRACT AND SUPPLY AIR MODE

Pressing the appropriate button sets all units to extract or supply air mode, and you can change the operating speed according to your needs.





Optional: Wall panel with CO2 sensor

Product Benefits



Easy to install

Installing the ventilation system is child's play. The electronics are installed inside the unit. The average time required for assembly approx. 1 hour. Thanks to integrated sensors the units control themselves automatically following installation.



Extremely easy to clean

Removing just a few components makes cleaning almost child's play: with the exception of the electronic unit, simply washing out the filters and washing off the plastic parts (impeller, grille, etc.) suffices to service the unit periodically. An LED light indicates when servicing is required.



Connecting the units

The units can be connected by cable or wirelessly. This also provides for beneficial ventilation functions such as FREECOOLING in the summer.



12 Product design layout



Manual on/off switch

Questions & Answers



Are our homes really full of contaminants and pollutants?

Yes indeed, although they are mostly invisible and odourless, exist dissolved in the air that we breathe in our homes and can attack the respiratory tract. They originate from paints and varnishes on walls and furniture, from smog and CO2 emissions, and from smoke and dust. Our decentralised home ventilation system lowers the concentration of radon in the air.



Does domestic ventilation impact upon on the energy consumption and efficiency of low-energy homes?

Not with Ambientika, the decentralised ventilation system with integrated heat recovery. A solid ceramic heat exchanger prevents the loss of heat during air exchange. The impact on the temperature – whether cold or warm – remains as small as possible.



A healthy living environment is also a quiet living environment, but what about a home ventilation system?

Thanks to its movable flaps, Ambientika is designed to isolate the exterior and interior. The flaps close and only open again when the air flow needs to be guaranteed. Their extremely quiet operation also guarantees peace and quiet, which makes our decentralised home ventilation systems incomparable.



Do home ventilation systems with an appealing design exist?

Our Ambientika decentralised home ventilation system is covered on the outside and the inside with a white cover. This means that the ventilation system is integrated discretely into the room's surroundings and its inner workings are hidden in a very discreet and elegant way.



How do I go about maintaining and cleaning the unit?

The air filter on the decentralised home ventilation unit should be cleaned every three months and replaced every two years. Replacing or cleaning the filter can be carried out in next to no time without the need for a separate tool.

Unique Design

Maximum functionality in minimalist design – our Ambientika decentralised home ventilation system fits elegantly and inconspicuously into the look of every home. The white ABS panels in an attractive design round off the high-quality materials and perfect workmanship of the unit perfectly.



FRONT VIEW

The DESIGN panel is attached to the wall in the living room.



COVER

Monocoque cover made of glossy white ABS in minimalist design.



FAN UNIT

Glossy white ABS in compact design.



PIPE

In PVC with a 160 mm diameter.



EXTERNAL GRILLE

Designed to protect against wind and noise from the outside.



REAR

The rear (paintable) is attached to the exterior wall of your home. UV-resistant.

Unit Properties

- ✓ ADVANCED + WIRELESS model: Including remote control or optional wall panel
- ✓ Compact, versatile and easy to use, with automatic programs for simplified use and ideal home comfort.
- ✓ No run-off needed for condensate
- ✓ ADVANCED + WIRELESS model: Free cooling operation possible in the summertime with at least 2 units
- ✓ Quiet operation
- ✓ Highly efficient, maintenance-free, EC motor
- ✓ For installation in external walls with 250 to 500 mm wall sleeves. Optional: Pipe extension
- ✓ Quick and easy access to the filter and heat exchanger
- ✓ Automatically closing flap mechanism
- ✓ Ceramic heat exchanger with up to 93% efficiency. Thermally insulated.
- ✓ Dual filters: one for fresh air and one for air extraction, easy to remove and clean. With optional pollen filter for allergy sufferers.
- ✓ Adjustable air volume of up to 60 m³/h
- ✓ Pressure capacity for distances of up to 3 m over smooth Ø 160 mm pipes. Up to 2.5 m with a 90° bend
- ✓ Minimal energy consumption
- ✓ No ventilation ducts required
- ✓ Exchange against existing wall fans without interfering with the building envelope
- ✓ ADVANCED + WIRELESS model: Integrated sensors monitor the function and control the units independently if desired (air humidity, light sensor or optionally CO₂)

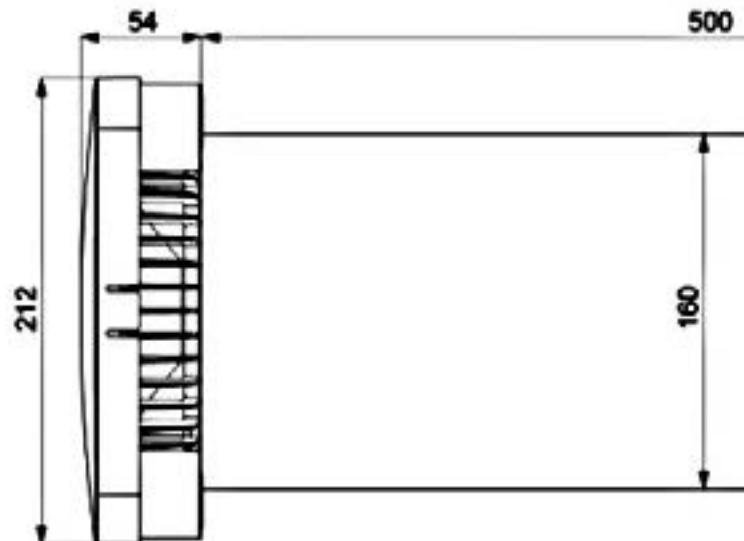
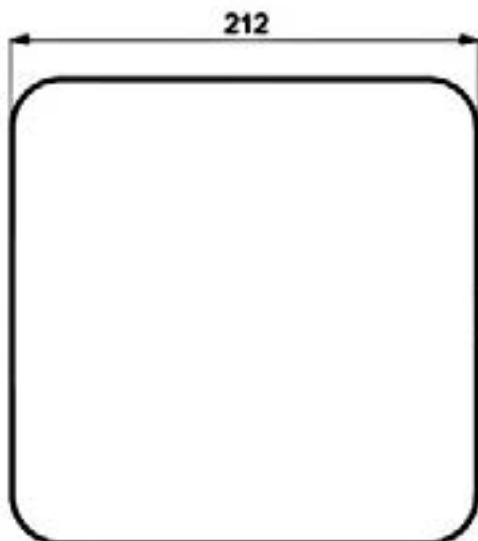

PARAMETERS	UNIT OF MEASUREMENT	VALUES
Air flow at maximum speed	m ³ /h	60
Ceramic heat recovery efficiency	%	93
Noise level at maximum speed (at 3m)	dB(A)	30
Noise level at min. speed (at 3m)	dB(A)	20
Operating temperature	°C	-20°C +50°C
Power	W	ø 6,7
Filter	N°	2
Filter class: EN 779	-	G3
Power supply	V/Hz	230 Vac – 50 Hz
Protection Class	-	IP44
Soundproofing against external noise	dB(A)	43

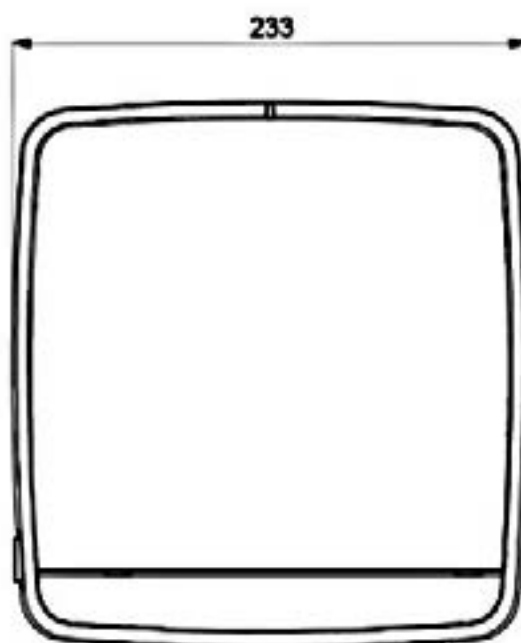
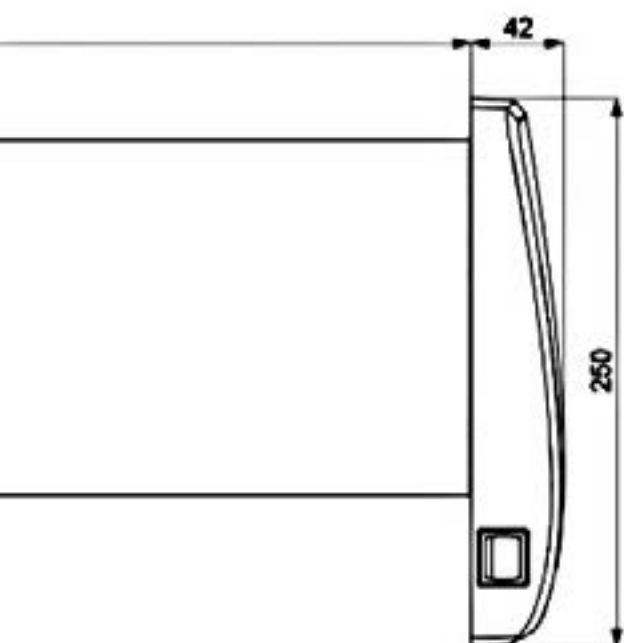

For reseller

Are you a professional installer?

If you are interested in reselling our products, or you are a professional installer, you can require access to our online shop as a retailer and make use of your VAT.

All you need to do is first register in the store and fill in the form.

We support planners and installers!

Controlled domestic ventilation systems offer a significant increase in the quality of life and well-being. They help private customers save energy and deliver arguments for planners in favour of the installation of decentralised units for the ventilation system. Ambientika, the decentralised domestic ventilation system with heat recovery, is unique among comparable products: It combines innovative technology with extraordinarily simple, intuitive controls.

Convincing sales arguments



Air quality as the key to well-being

Pollutants are mostly invisible and odourless.

They come from paints and coatings on walls and furniture, smog and CO2 emissions, and fumes and dust. Damp and poorly ventilated rooms encourage infestations of mould, mites and bacteria, which can cause harm to the respiratory tract. When installed correctly, Ambientika, the decentralised domestic ventilation system with heat recovery, can reduce radon levels.



Reduced heating costs

In most cases, heating energy can be recovered from the extract air. As heating energy is an expensive item, this is a significant advantage. Ask the experts: Ambientika is happy to support planners with the right arguments for controlled domestic ventilation with heat recovery.



Environmental, noise and burglary protection

A healthy living environment is also a quiet one. With Ambientika, planners have a whole series of sales arguments for the installation of a decentralised ventilation system.

In terms of eco-friendliness, heat recovery saves energy and helps reduce carbon emissions.

Home security also benefits: With the Ambientika ventilation system, there is no need to leave windows open and so encourage burglars.

Advantages:

- ✓ Guaranteed high standard of quality
- ✓ Compact, versatile, user-friendly
- ✓ Distinctive design
- ✓ Minimum noise emissions
- ✓ Energy savings
- ✓ Top-quality materials
- ✓ Automatic operation, ideal for rental properties
- ✓ Simple installation in line with industry codes

Finding the right domestic ventilation

Free specialist consulting, planning and preparation of a ventilation concept according to DIN 1946-6 (also valid for submission to apply for state support).

Please send us the layout plan and let us know whether you would like to link up the ventilation system via cable or wireless.



Start planning



süd  **wind**

One of the quietest systems on the market.

info@ambientika.eu

www.ambientika.eu